

Junior  
Certificate  
School  
Programme

# Sum Zone

## Measurement of Regular Shapes

Student Workbook

## Contents

Chapter 1	Perimeter and Area of Squares	Page 3
Chapter 2	Perimeter and Area of Rectangles	Page 6
Chapter 3	Perimeter and Area of L Shapes	Page 11
Chapter 4	Perimeter and Area of T Shapes	Page 18
Chapter 5	Area of Triangles	Page 25
Chapter 6	Volume and Surface Area of Cubes	Page 29
Chapter 7	Volume and Surface Area of Rectangular Blocks	Page 32

## Chapter 1

### Perimeter and Area of Squares

1. (i) Find the perimeter of this square if each side is 15 cm in length.  
(ii) Find the area of this square.

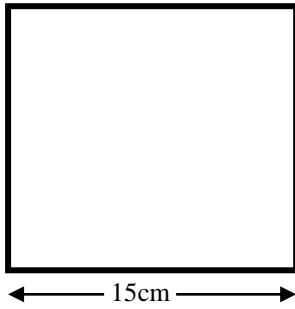

15cm

(i)

(ii)

2. (i) Find the perimeter of this square if each side is 35 cm in length.  
(ii) Find the area of this square.

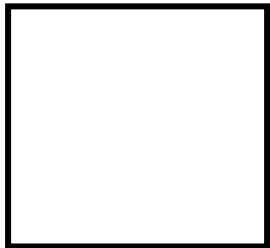

35cm

(i)

(ii)

3. (i) Find the perimeter of this square if each side is 132 cm in length.  
(ii) Find the area of this square.

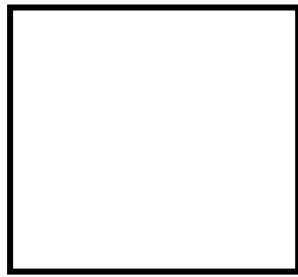

← 132 cm →

(i)	(ii)
-----	------

4. (i) Find the perimeter of this square if each side is 108 cm in length.  
(ii) Find the area of this square.



← 108 cm →

(i)	(ii)
-----	------

5. (i) Find the perimeter of this square if each side is 112.5 cm in length.  
(ii) Find the area of this square.

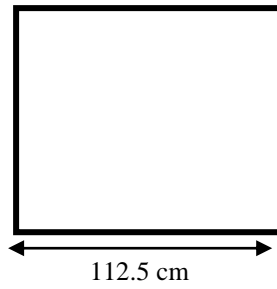

(i)	(ii)
-----	------

6. (i) Find the perimeter of this square if each side is 75 cm in length.  
(ii) Find the area of this square.

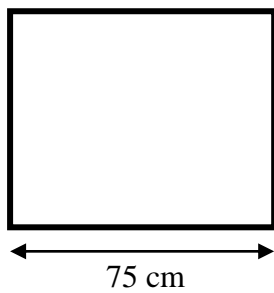

(i)	(ii)
-----	------

## Chapter 2

### Perimeter and Area of Rectangles

1. (i) Find the perimeter of this rectangle.  
(ii) Find the area of this rectangle.

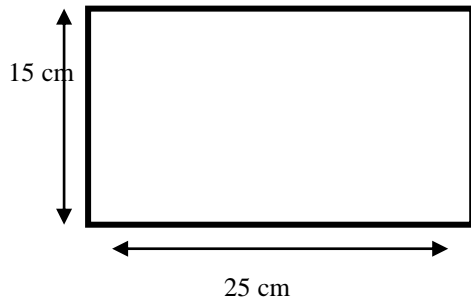

(i)	(ii)
-----	------

2. (i) Find the perimeter of this rectangle.  
(ii) Find the area of this rectangle.

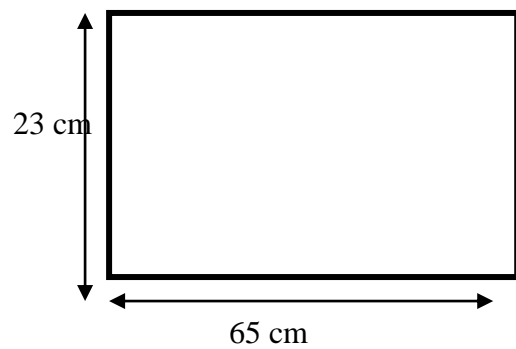

(i)	(ii)
-----	------

3. Find the perimeter of this rectangle.  
Find the area of this rectangle.

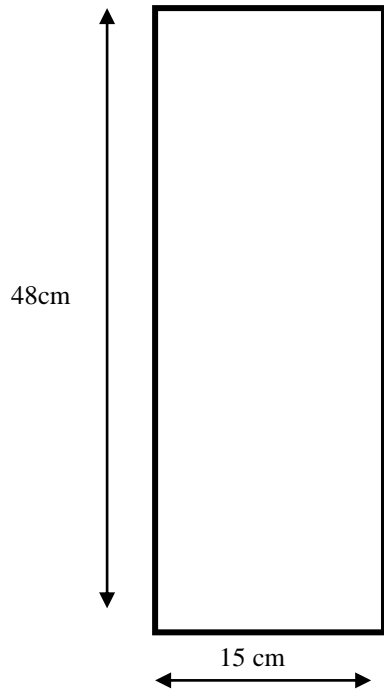

(i)	(ii)
-----	------

4. (i) Find the perimeter of this rectangle.  
(ii) Find the area of this rectangle.

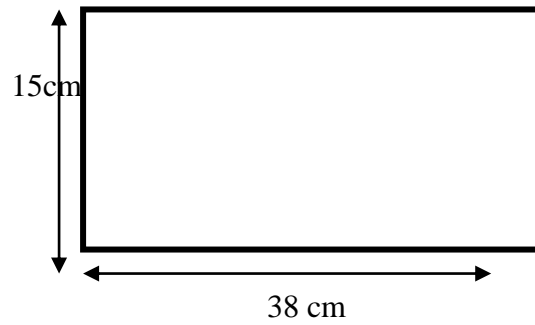

(i)	(ii)
-----	------

4. (i) Find the perimeter of this rectangle.  
(ii) Find the area of this rectangle.

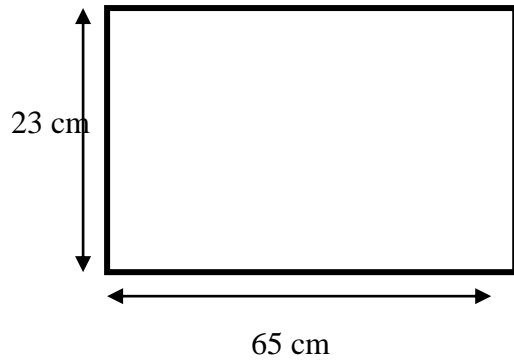

(i)	(ii)
-----	------

- 5 (i) Find the perimeter of this rectangle.  
(ii) Find the area of this rectangle.

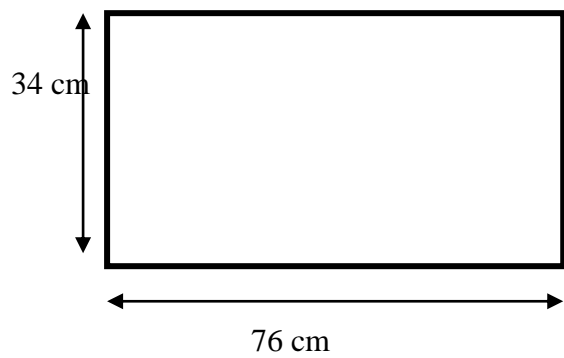

(i)	(ii)
-----	------



6. (i) Find the perimeter of this rectangle.  
(ii) Find the area of this rectangle.

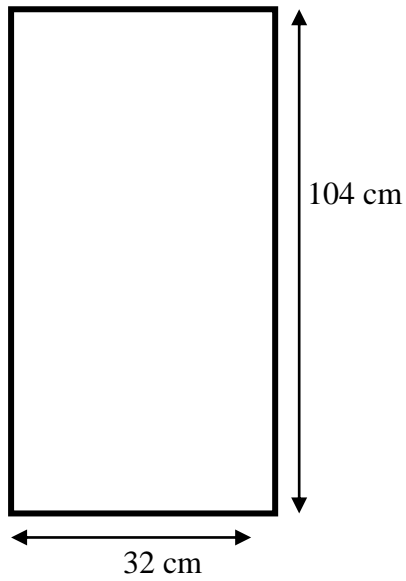

(i)	(ii)
-----	------

7. Find the perimeter of this rectangle.  
Find the area of this rectangle.

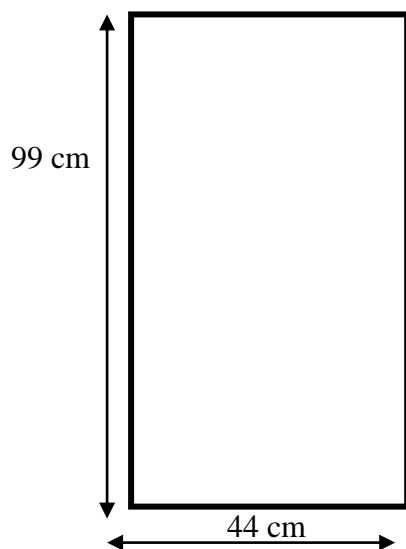

(i)	(ii)
-----	------

8. (i) Find the perimeter of this rectangle.  
(ii) Find the area of this rectangle.

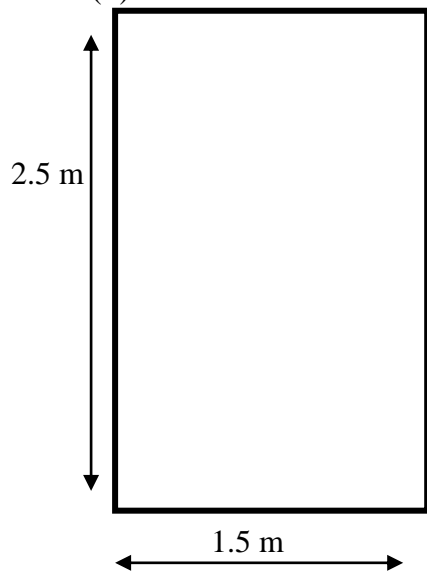

(i)	(ii)
-----	------

9. (i) Find the perimeter of this rectangle.  
(ii) Find the area of this rectangle.

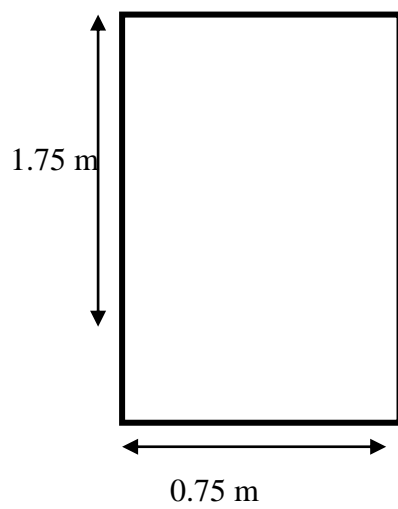

(i)	(ii)
-----	------

## Chapter 3

### Perimeter and Area of L Shapes

1. (i) Find the perimeter of this L shaped building.  
(ii) Find the area of this building

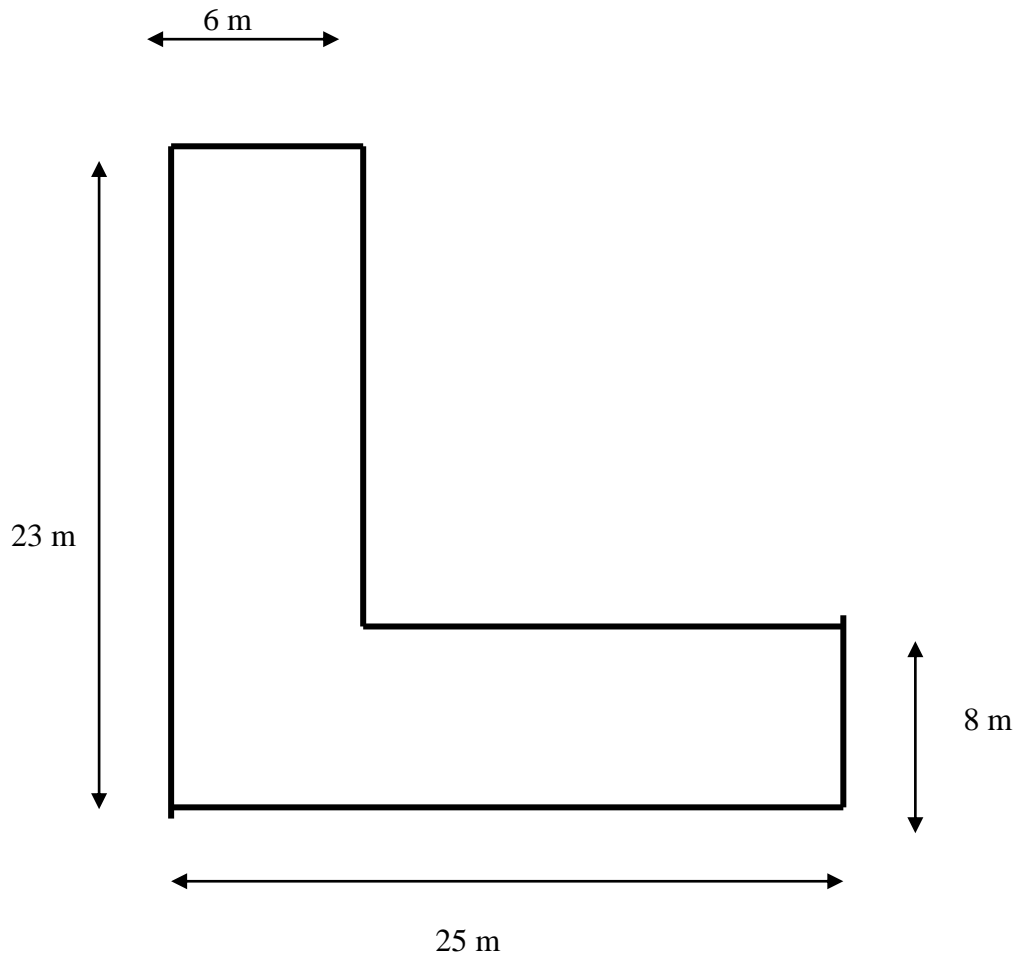

(i)	(ii)
-----	------

2. (i) Find the perimeter of this L shaped building.  
(ii) Find the area of this building.

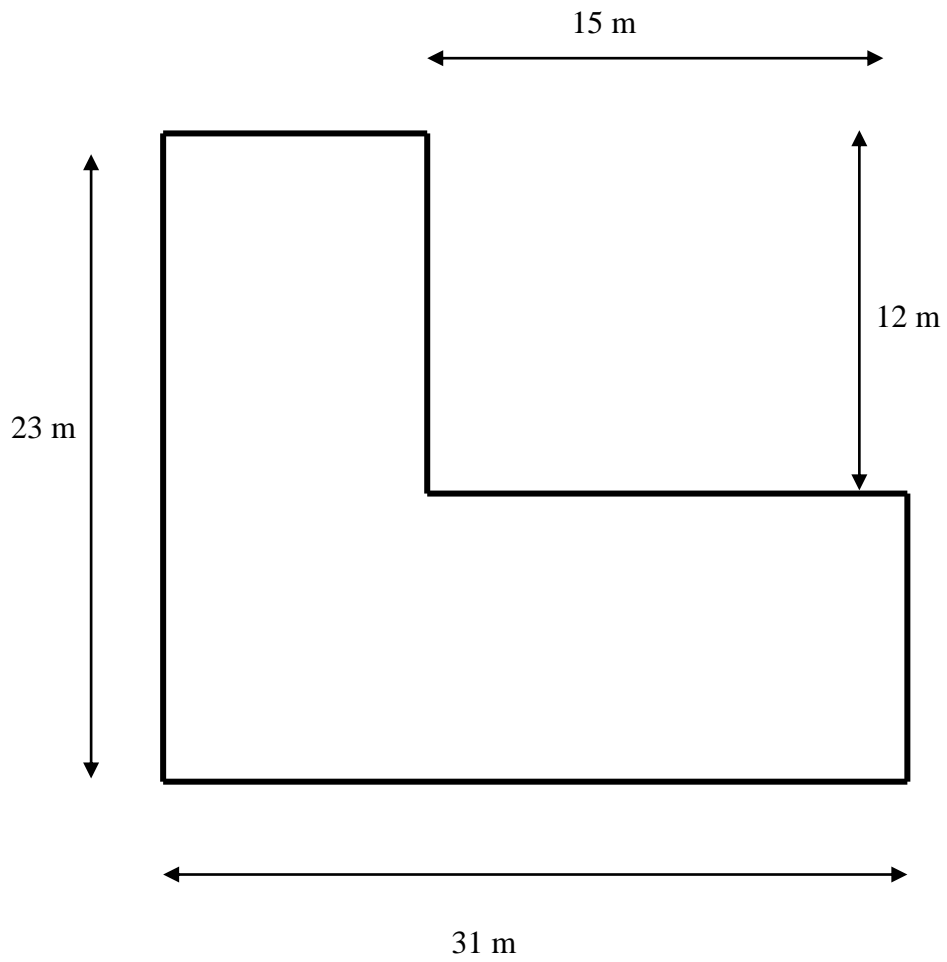

(i)	(ii)
-----	------

3. (i) Find the perimeter of this L shaped building.  
(ii) Find the area of this building.

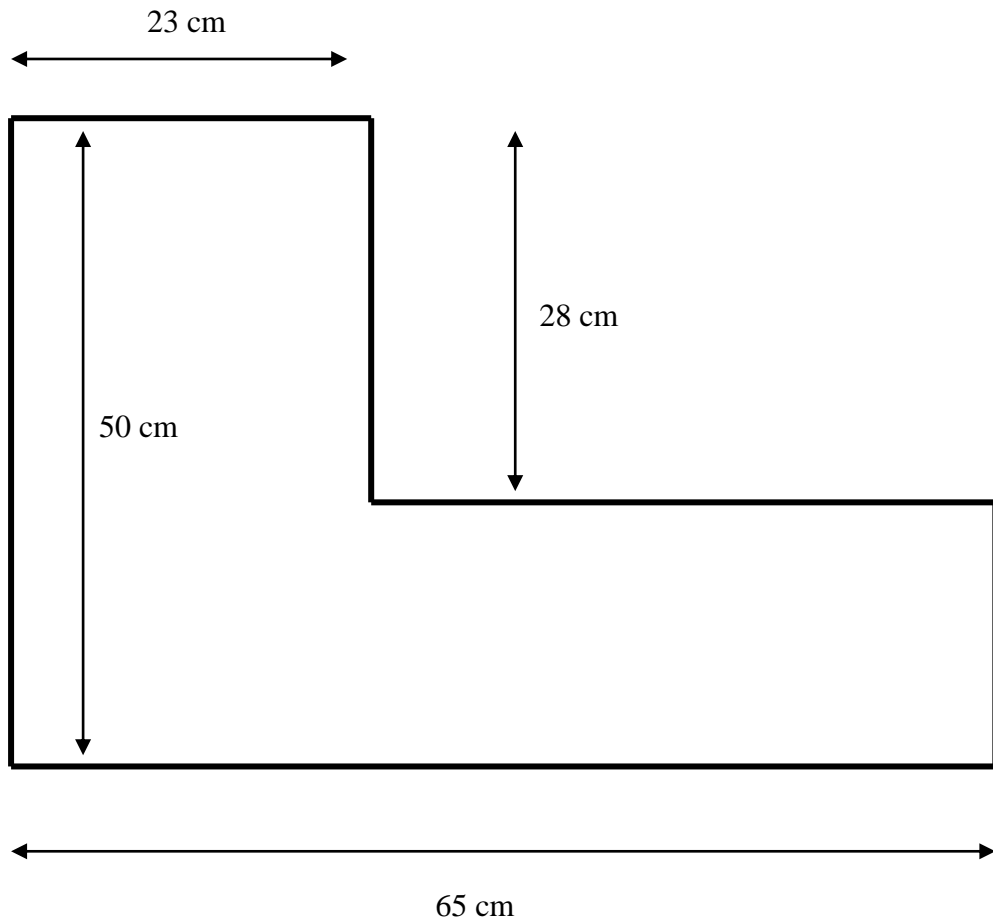

(i)	(ii)
-----	------

4. (i) Find the perimeter of this L shaped building.  
(ii) Find the area of this building.

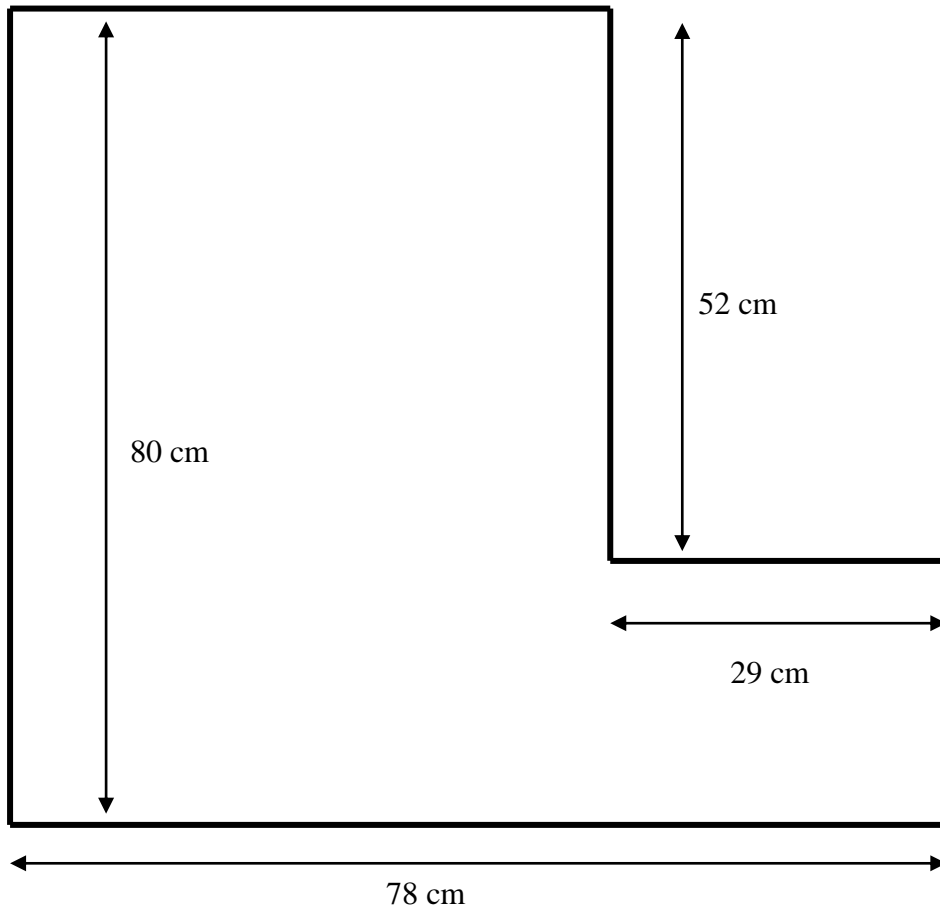

(i)	(ii)
-----	------

5. (i) Find the perimeter of this L shaped building.  
(ii) Find the area of this building.

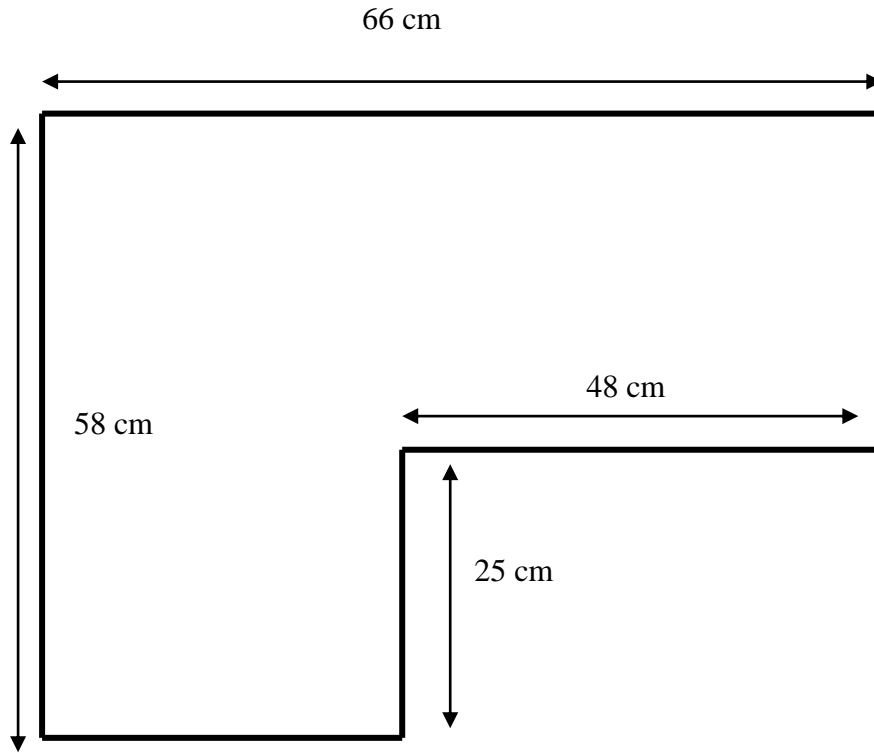

(i)

(ii)

6. (i) Find the perimeter of this L shaped building.  
(ii) Find the area of this building.

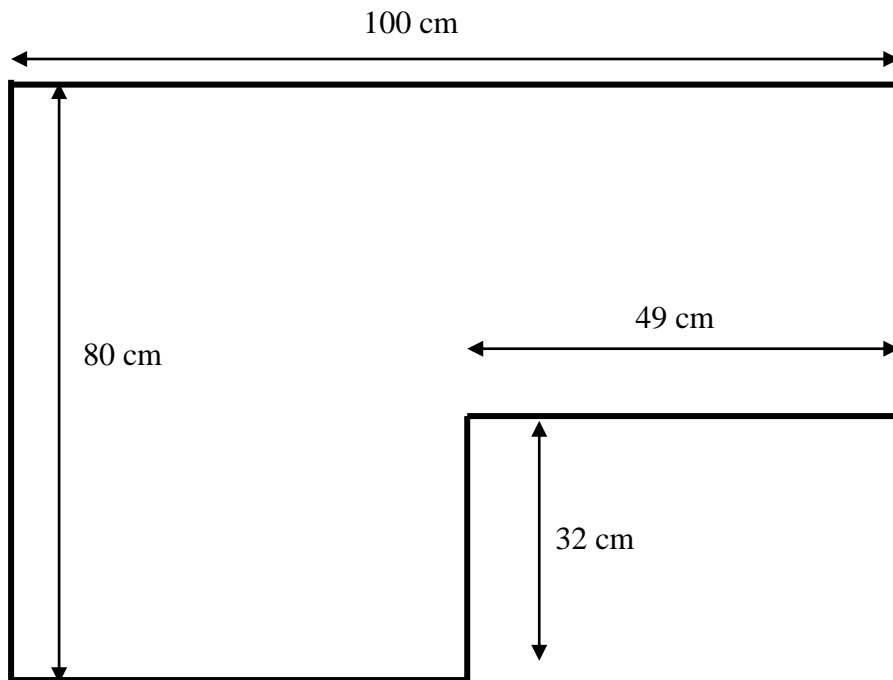

(i)	(ii)
-----	------



7. (i) Find the perimeter of this L shaped building.  
(ii) Find the area of this building.

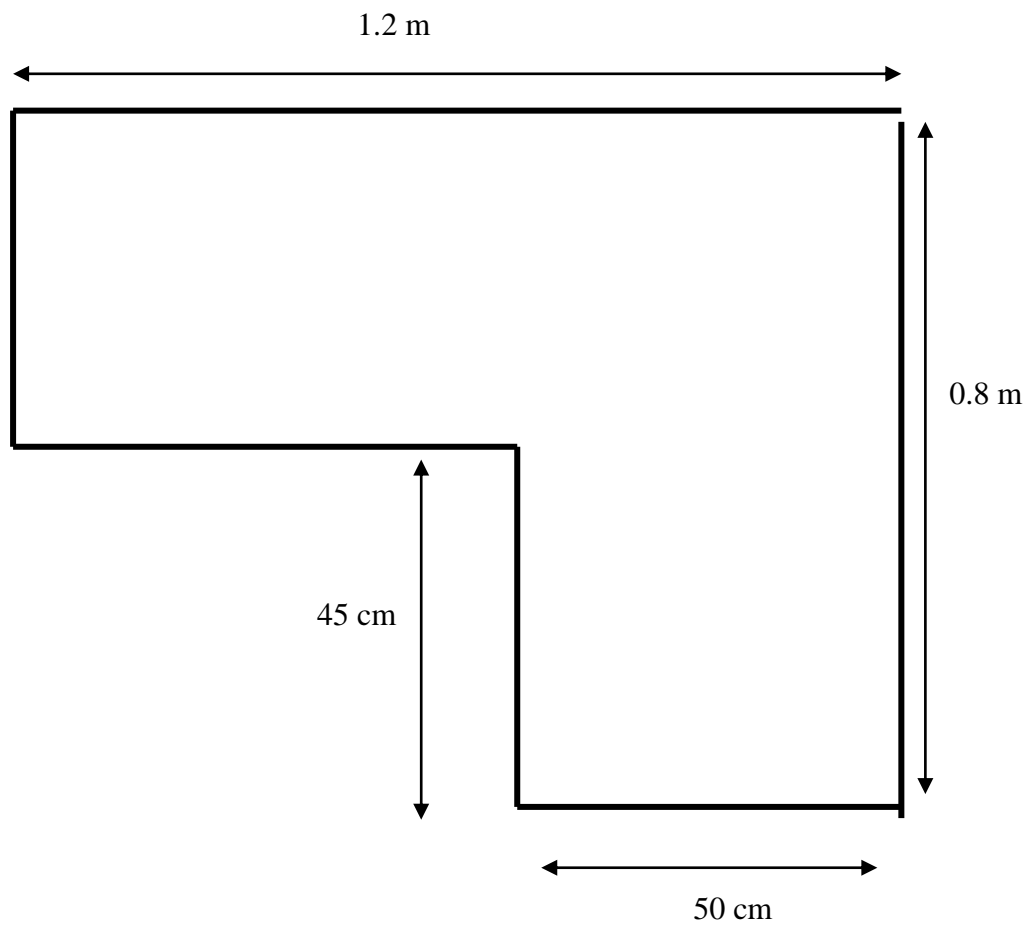

(i)	(ii)
-----	------

## Chapter 4

### Perimeter and Area of T Shapes

1. (i) Find the perimeter of this T shaped building.  
(ii) Find the area of this building.

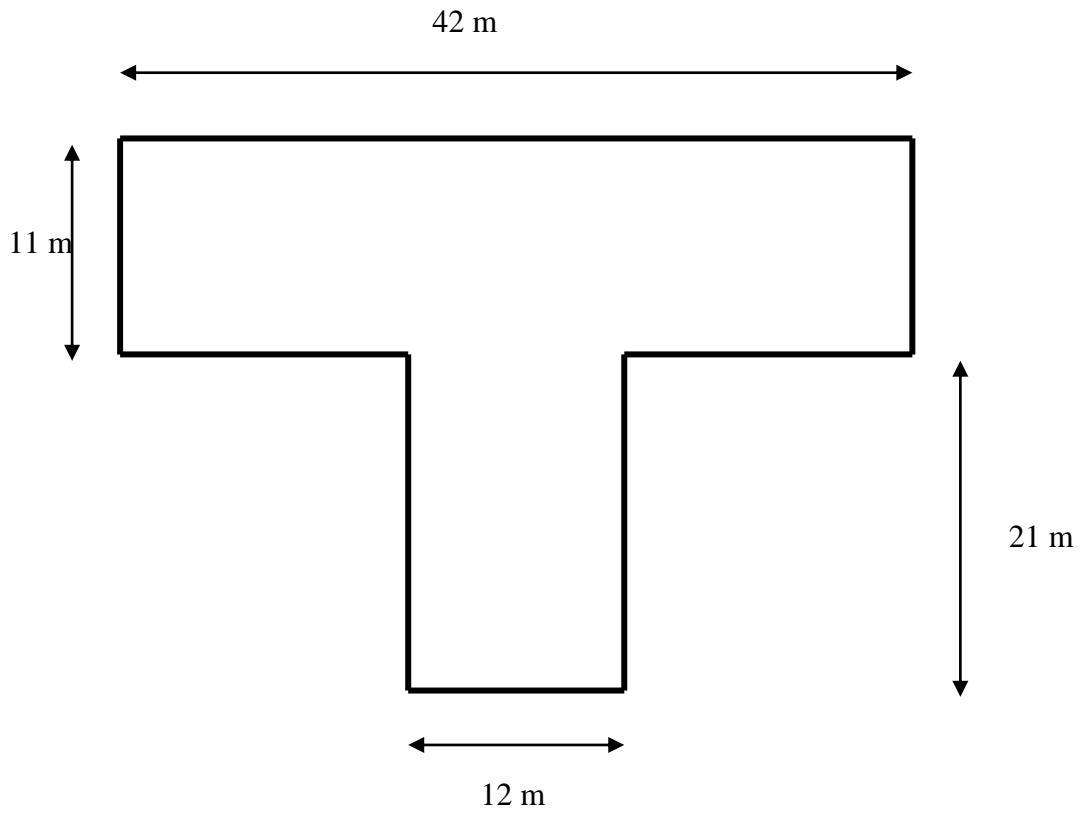

(i)	(ii)
-----	------

2. (i) Find the perimeter of this T shaped building.  
(ii) Find the area of this building.

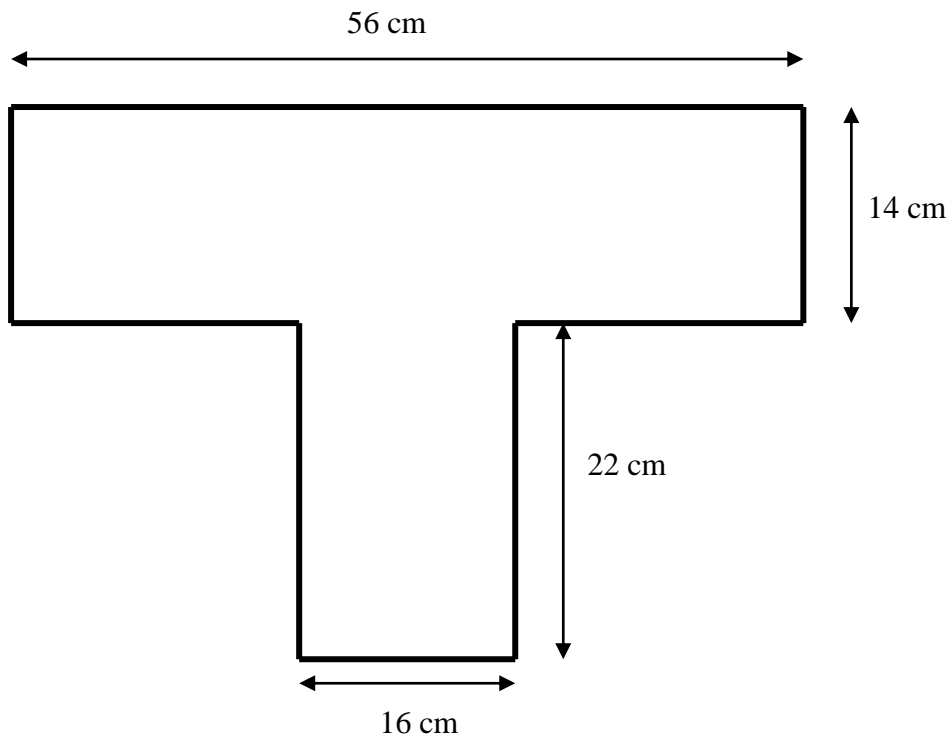

(i)	(ii)
-----	------

3. (i) Find the perimeter of this T shaped building.  
(ii) Find the area of this building.

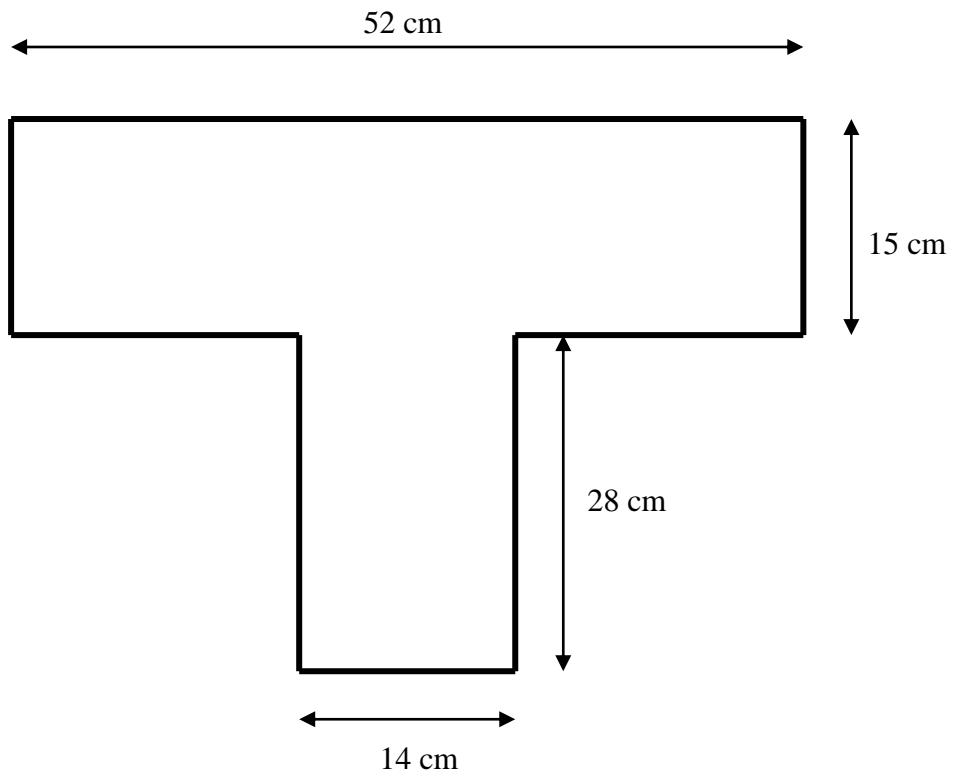

(i)	(ii)
-----	------

4. (i) Find the perimeter of this T shaped building.  
(ii) Find the area of this building.

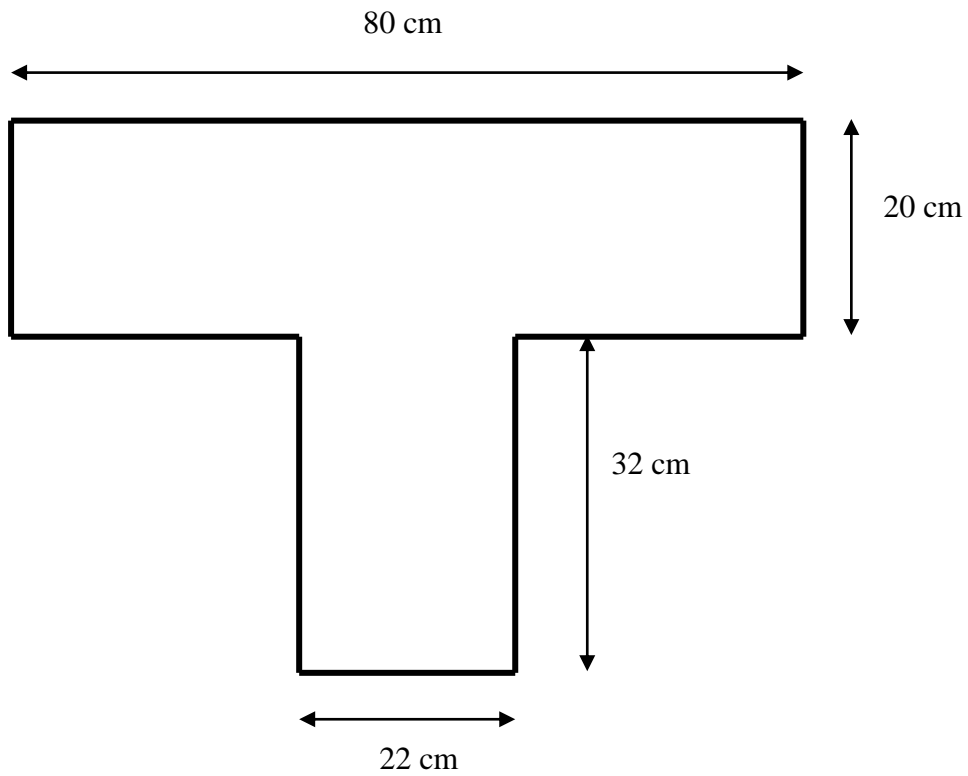

(i)	(ii)
-----	------

5. (i) Find the perimeter of this T shaped building.  
(ii) Find the area of this building.

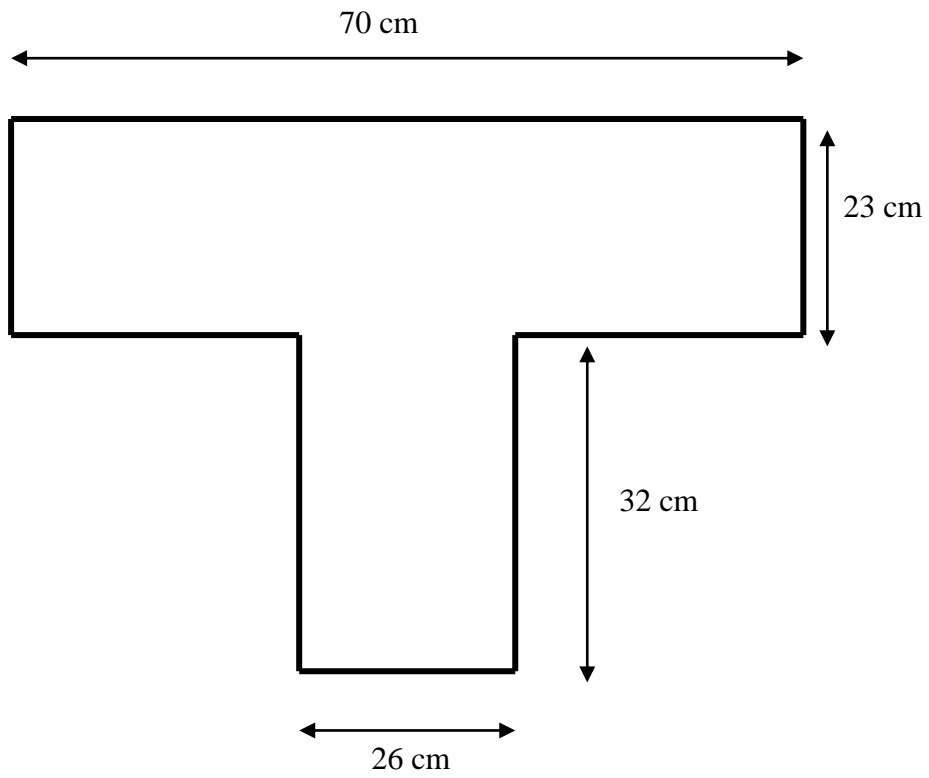

(i)	(ii)
-----	------

6. (i) Find the perimeter of this T shaped building.  
(ii) Find the area of this building.

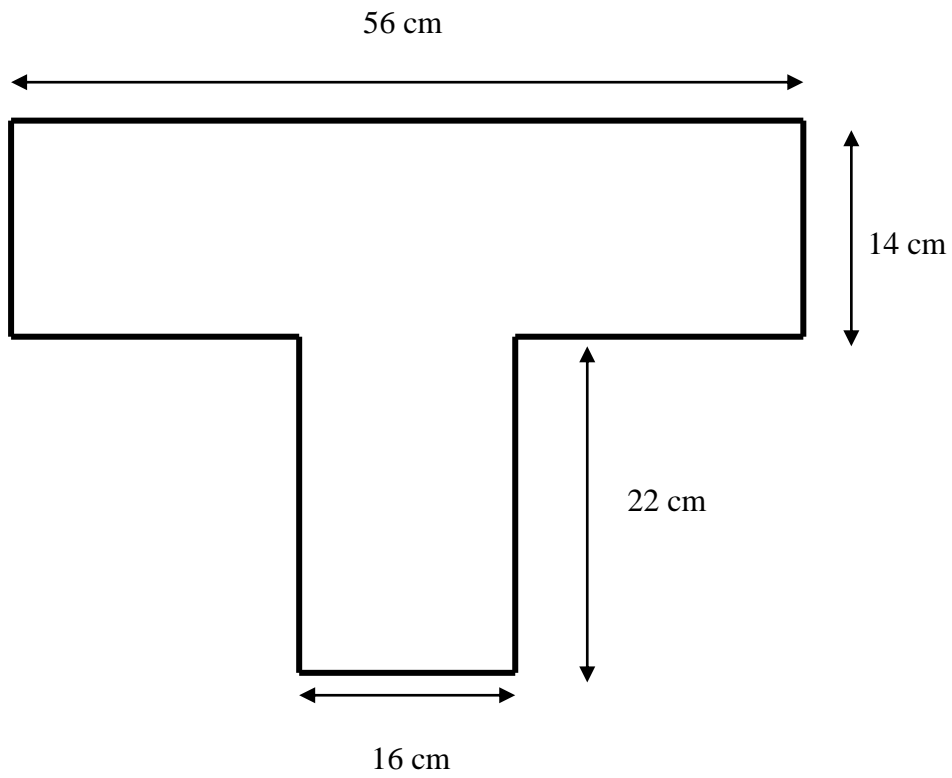

(i)	(ii)
-----	------

7. (i) Find the perimeter of this T shaped building.  
(ii) Find the area of this building.

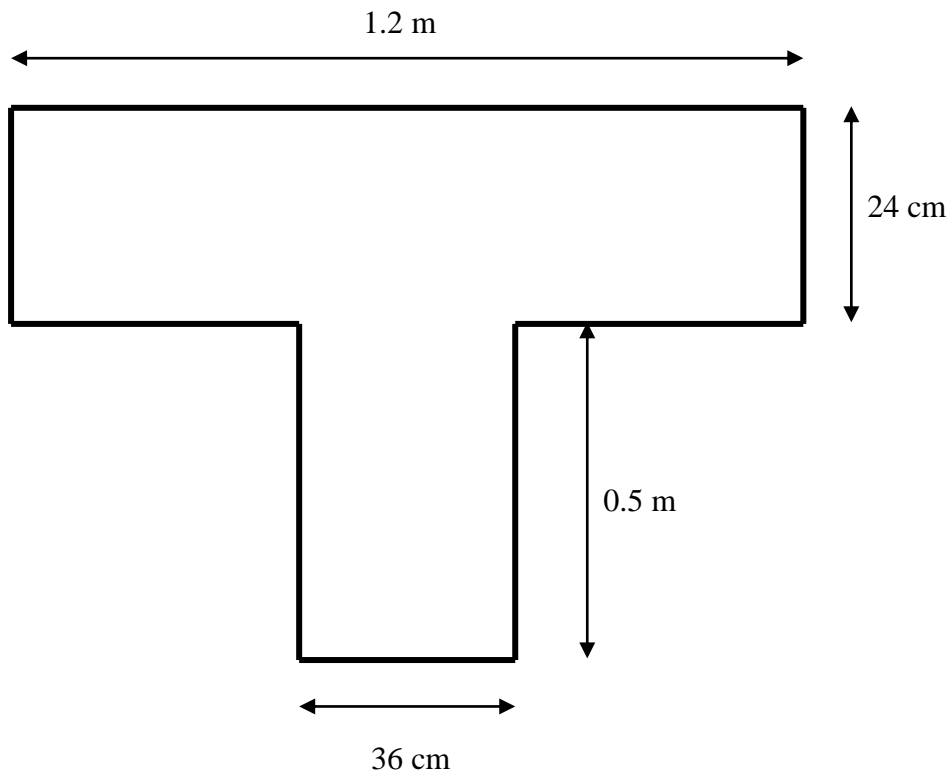

(i)	(ii)
-----	------



## Chapter 5

### Area of Triangles

1. Find the area of this triangle.

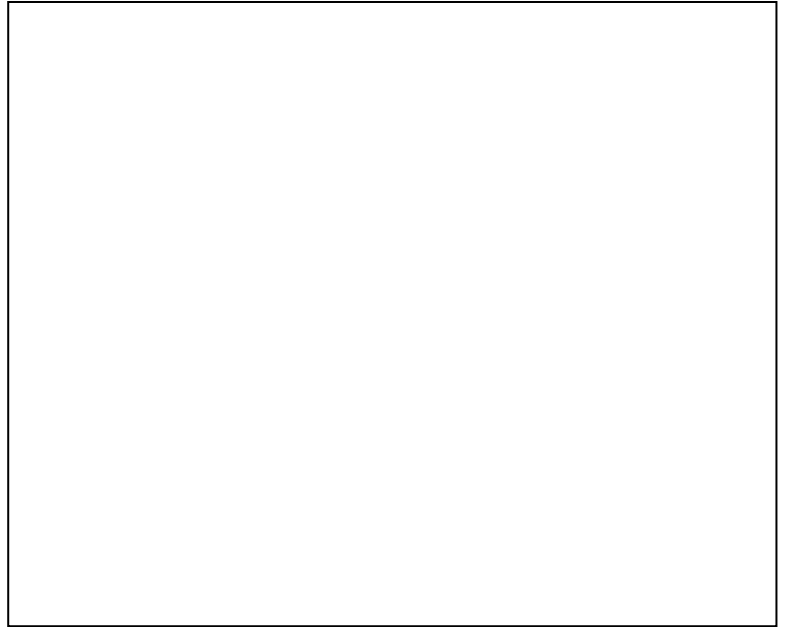
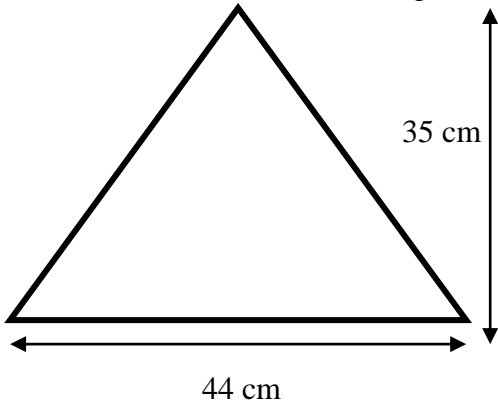

2. Find the area of this triangle.

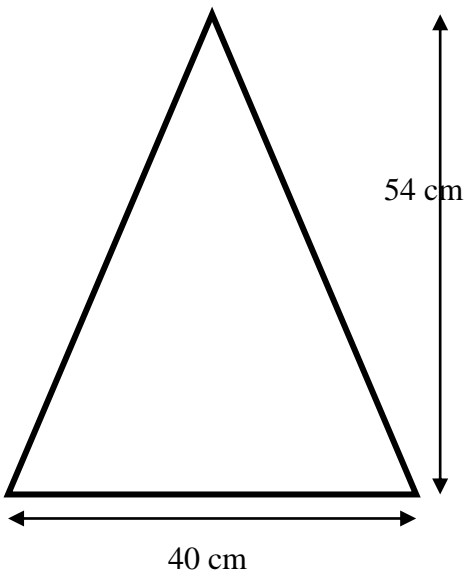

3. Find the area of this triangle.

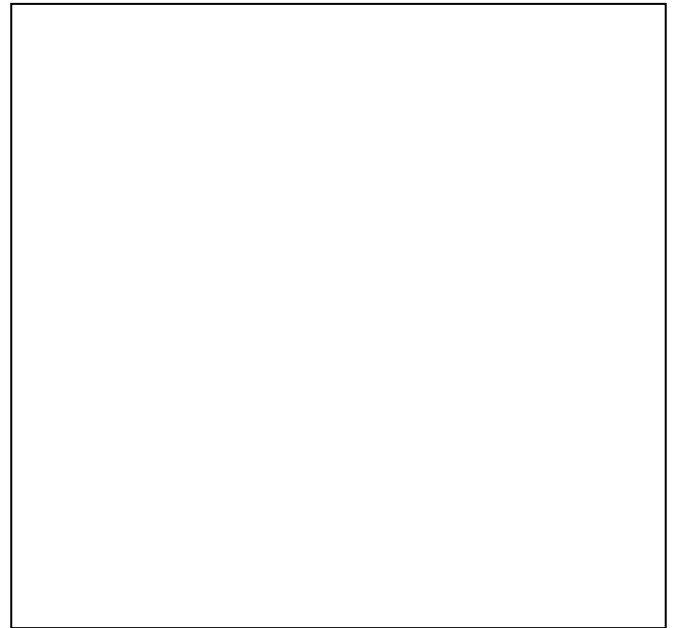
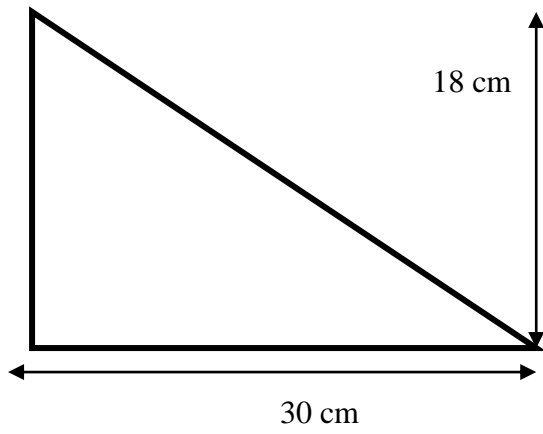

4. Find the area of this triangle.

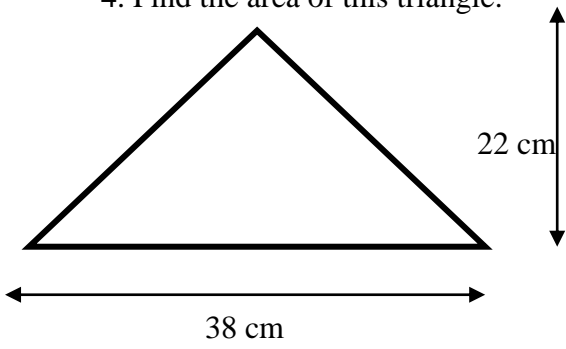

5. Find the area of this triangle.

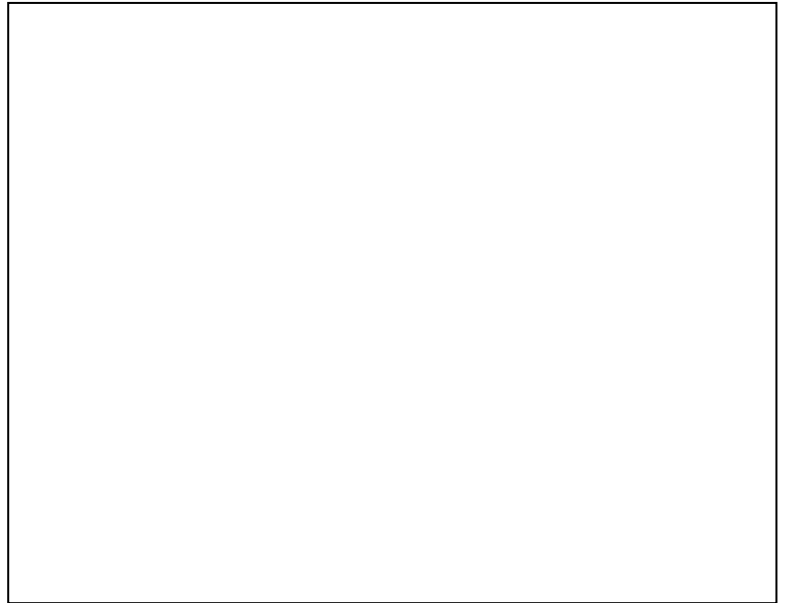
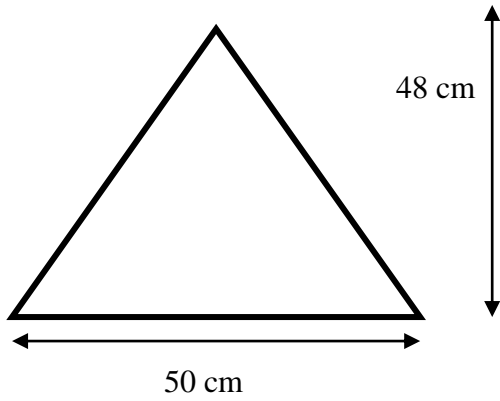

6. Find the area of this triangle.

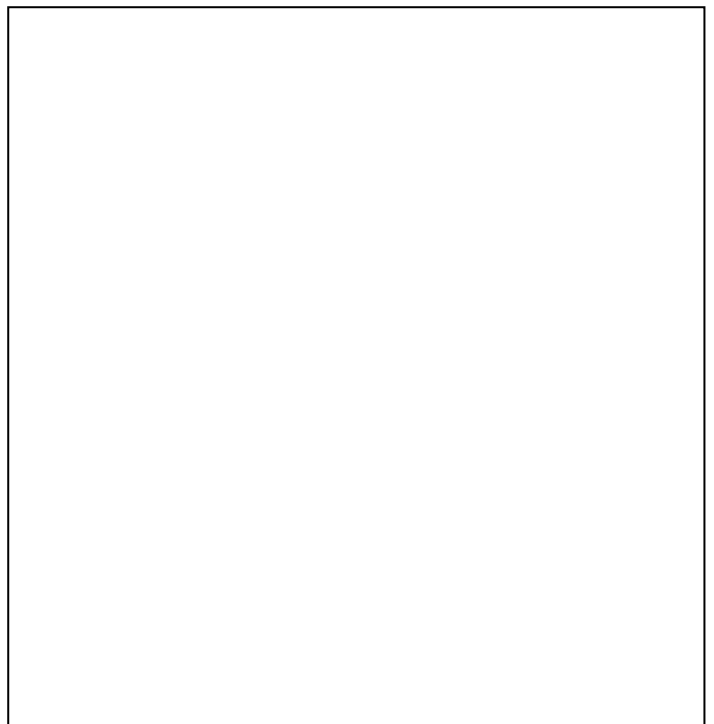
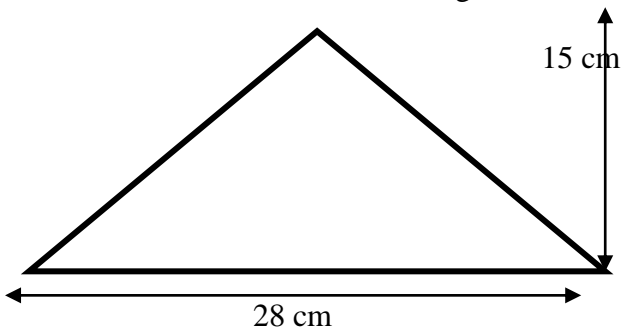

7. Find the area of this triangle.

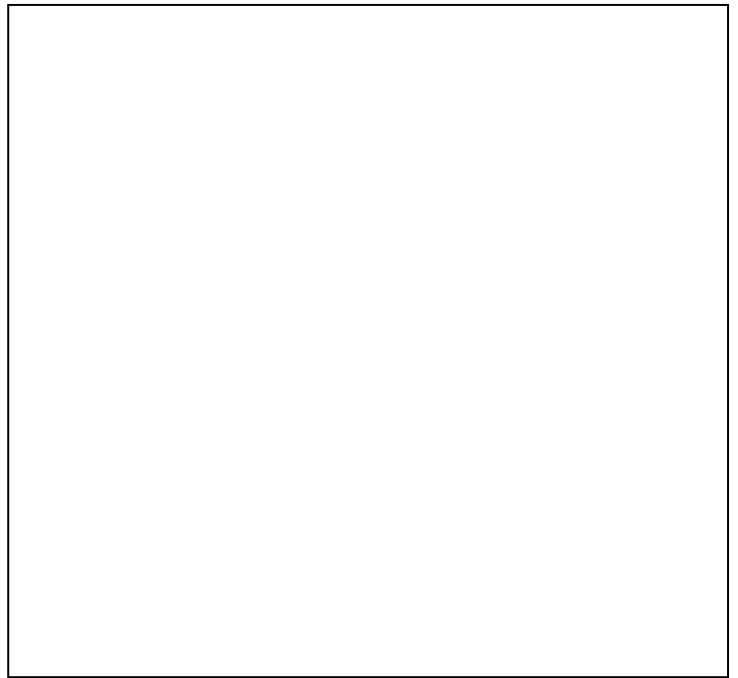
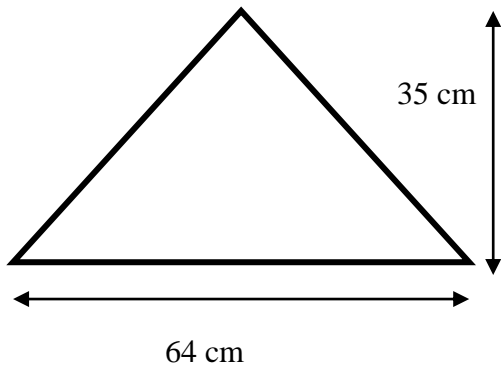

8. Find the area of this triangle.

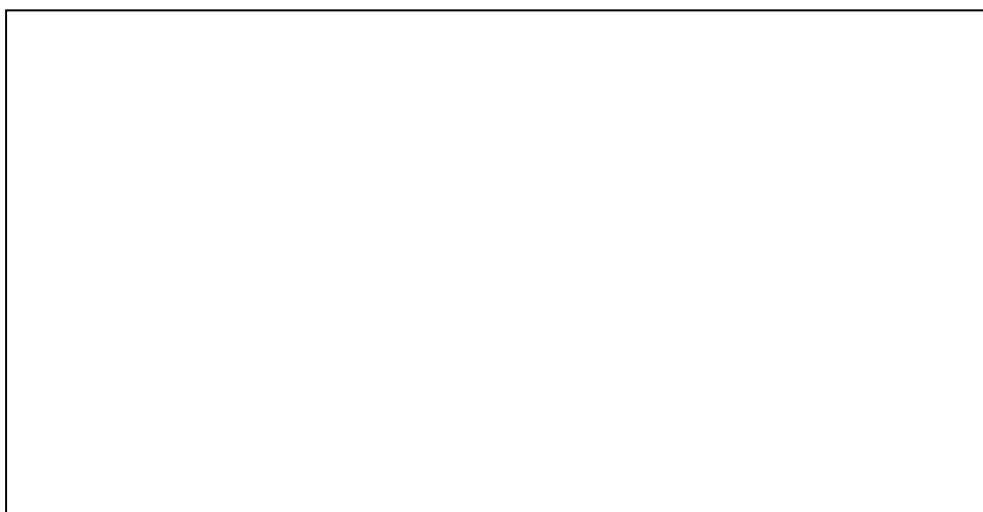
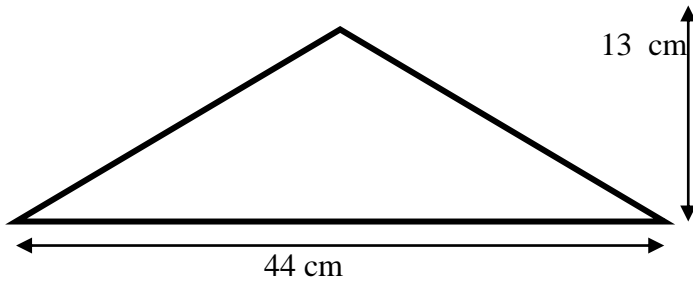

## Chapter 6

### Volume and Surface Area of Cubes

1. (i) Find the volume of this cube.  
(ii) Find the total surface area of the cube.

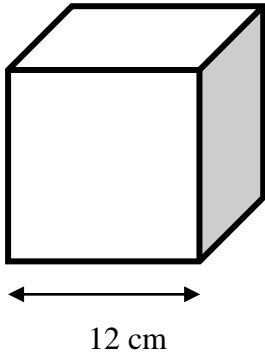

(i)	(ii)
-----	------

2. (i) Find the volume of the following cube.  
(ii) Find the total surface area of the cube.

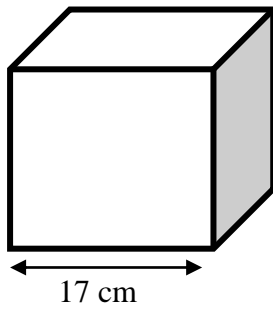

(i)	(ii)
-----	------

3. (i) Find the volume of the following cube.  
(ii) Find the total surface area of the cube.

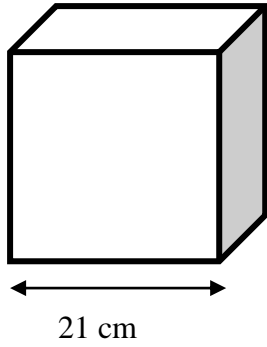

(i)	(ii)

4. (i) Find the volume of the following cube.  
(ii) Find the total surface area of the cube.

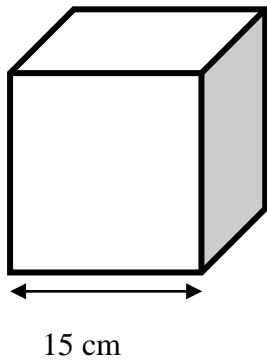

(i)	(ii)

5. (i) Find the volume of the following cube.  
(ii) Find the total surface area of the cube.

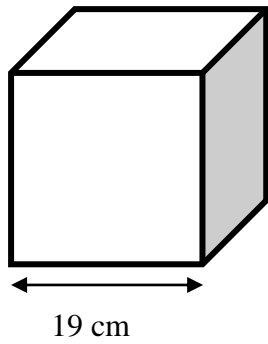

(i)

(ii)

6. (i) Find the volume of the following cube.  
(ii) Find the total surface area of the cube.

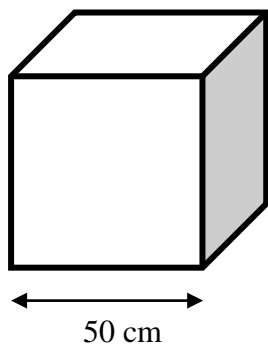

(i)

(ii)

## Chapter 7

### Volume and Surface Area of Rectangular Blocks

1. (i) Find the volume of the following rectangular block.  
(ii) Find the total surface area of this rectangular block.

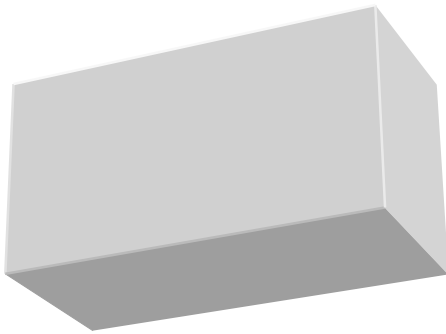

Length: 20 cm

Width: 9cm

Height: 12 cm

(i)

(ii)



2. (i) Find the volume of the following rectangular block.  
(ii) Find the total surface area of this rectangular block.



Length: 23 cm

Width: 11 cm

Height: 15 cm

(i)

(ii)

3. (i) Find the volume of the following rectangular block.  
(ii) Find the total surface area of this rectangular block.

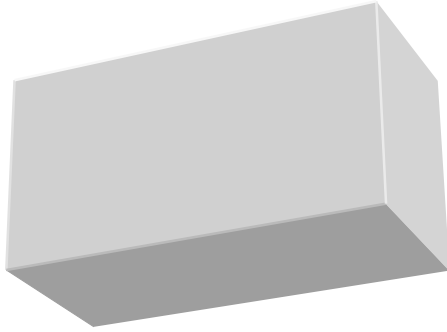

Length: 25 cm

Width: 10 cm

Height: 15 cm

(i)	(ii)
-----	------

4. (i) Find the volume of the following rectangular block.  
(ii) Find the total surface area of this rectangular block.

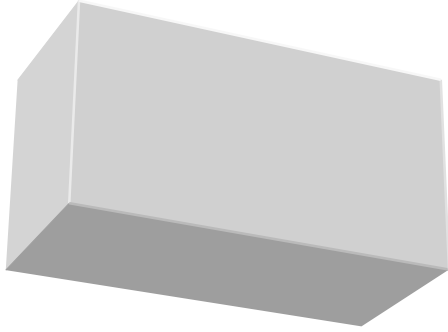

Length: 18 cm

Width: 9 cm

Height: 11 cm

(i)

(ii)

5. (i) Find the volume of the following rectangular block.  
(ii) Find the total surface area of this rectangular block.

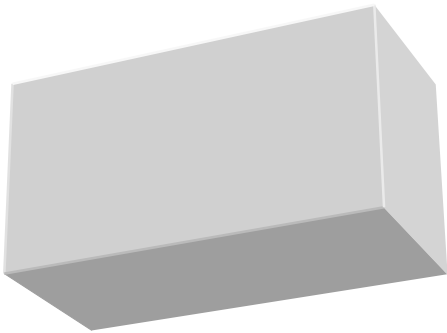

Length: 22 cm

Width: 8 cm

Height: 13 cm

(i)

(ii)

6. (i) Find the volume of the following rectangular block.  
(ii) Find the total surface area of this rectangular block.

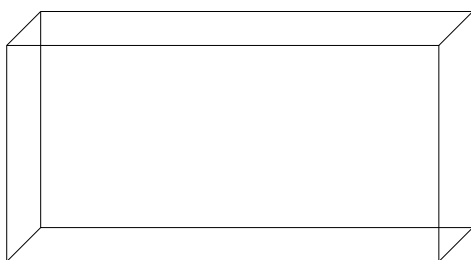

Length: 44 cm

Width: 18 cm

Height: 30 cm

(i)	(ii)
-----	------

7. (i) Find the volume of the following rectangular block.  
(ii) Find the total surface area of this rectangular block.

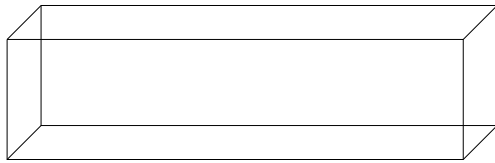

Length: 23 cm

Width: 9 cm

Height: 11 cm

(i)

(ii)

8. (i) Find the volume of the following rectangular block.  
(ii) Find the total surface area of this rectangular block.

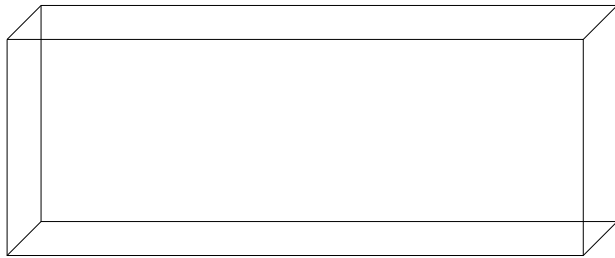

Length: 36 cm

Width: 11 cm

Height: 21 cm

(i)

(ii)

9. (i) Find the volume of the following rectangular block.  
(ii) Find the total surface area of this rectangular block.

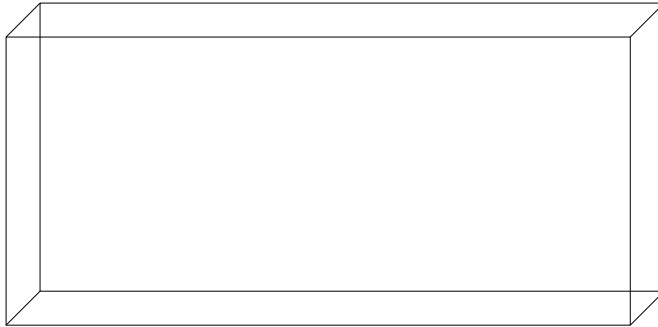

Length: 33 cm

Width: 9 cm

Height: 21 cm

(i)

(ii)



10. (i) Find the volume of the following rectangular block.  
(ii) Find the total surface area of this rectangular block.

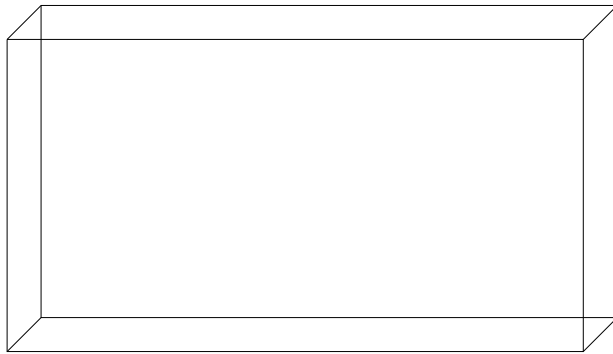

Length: 42 cm

Width: 7 cm

Height: 28 cm

(i)

(ii)

Professional Development Service for Teachers  
Junior Certificate School Programme  
Blackrock Education Centre  
Kill Avenue  
Dun Laoghaire  
Co Dublin  
Ph: 01-2365000  
Mail: [jcsp@pdst.ie](mailto:jcsp@pdst.ie)

